

8' X 12' BANNER STAND PARTS

ADJUSTABLE FROM 48" - 144" WIDTH AND 36" - 144" HEIGHT

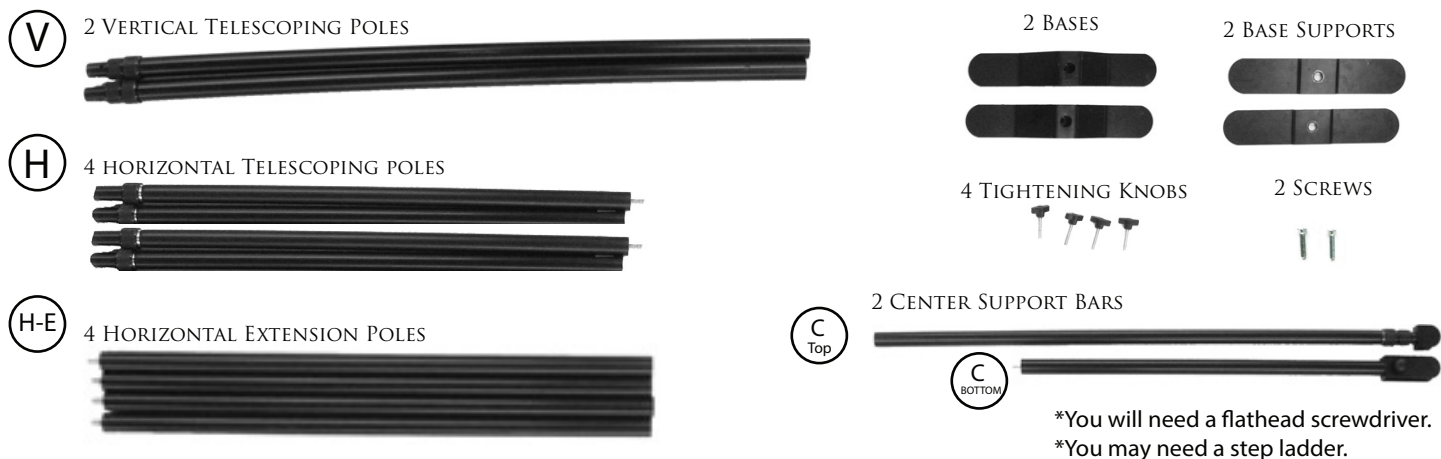

GETTING STARTED...

Make sure that you have all tools and parts. Set up stand on an even surface. Avoid windy areas. As this size stand is fairly large, set-up is best done with two people although it can be done without any assistance. The stand can be set up while laying it on a clean, flat surface. This is the best way to construct the stand if you have the space to do so or are setting this up solo. If not, the stand can be set up with it standing upright.

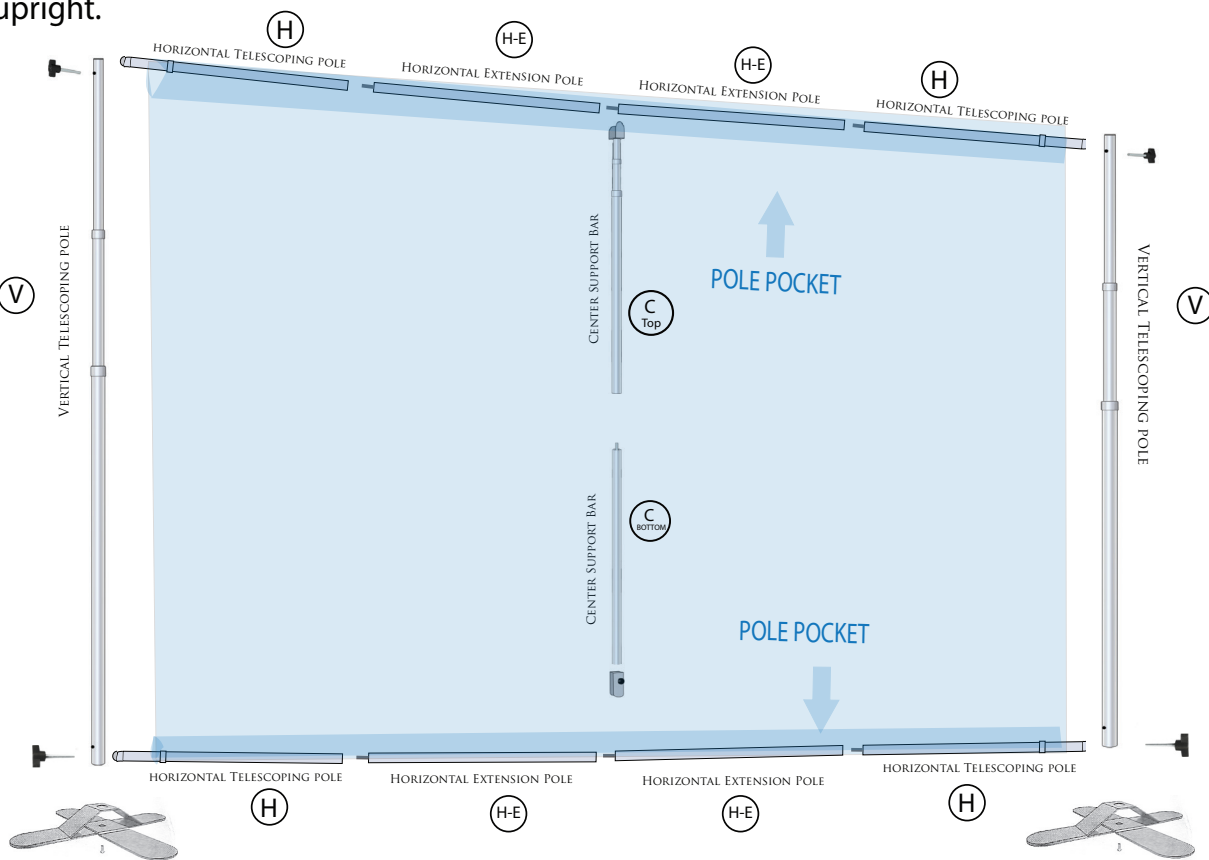

INSTRUCTIONS

These instructions will show you how to construct the stand using the upright option.

Lay the Base over the Base Support so that it forms an "X".

Connect the Base to the Vertical-Telescoping-Pole. Use a screw to secure pole to base. Repeat for other side.

Connect the horizontal poles together. The two Horizontal-Extension-Poles should be in the middle.

Set the vertical poles 12 feet apart.

Lay the rolled-up banner between the vertical poles.

Slide the joined horizontal pole through the pole pocket in the top of the banner.

Using screw-knobs, attach the horizontal pole with banner to the holes at the top of the vertical poles. **Caution: Do not overtighten.**

Attach Vertical Poles to Bases

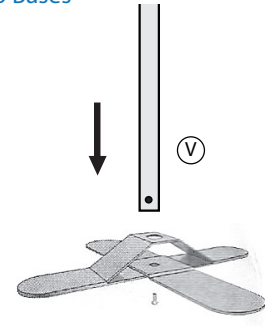

Connect Horizontal Poles

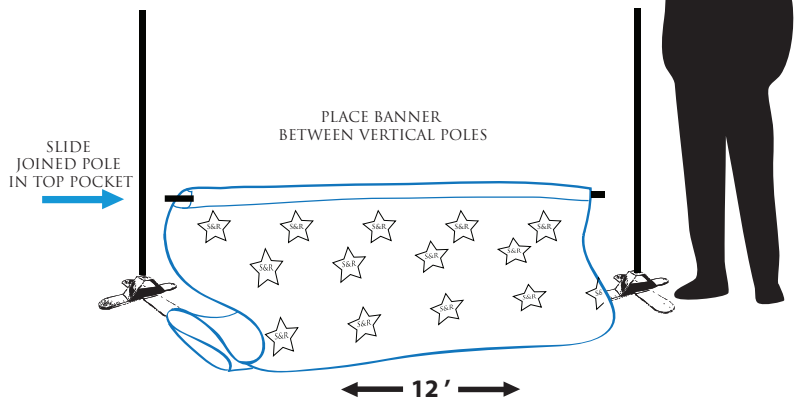

Gently tighten screws to connect Vertical Poles to Horizontal Poles

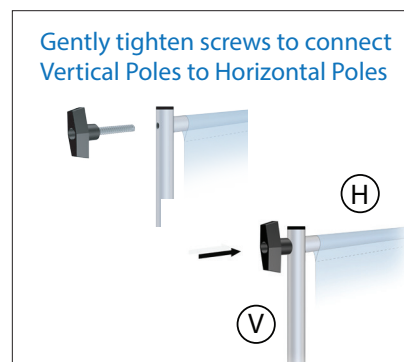

Extend the vertical poles while slowly unrolling the banner until the banner is hanging freely. Secure each telescoping pole by tightening clock-wise.

Caution: Do not overtighten.

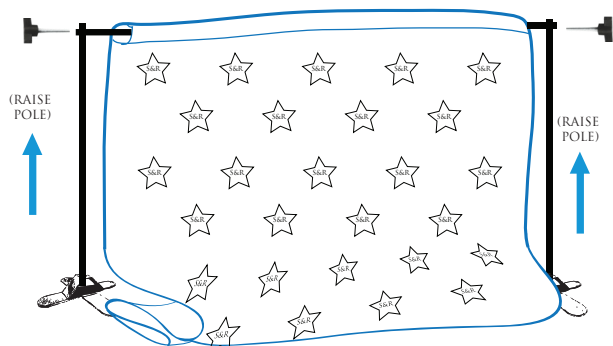

Now slide the other joined horizontal pole through the pole pocket in the bottom of the banner.

Using screw-knobs, attach the horizontal pole with banner to the holes at the bottom of the vertical poles.

Caution: Do not overtighten.

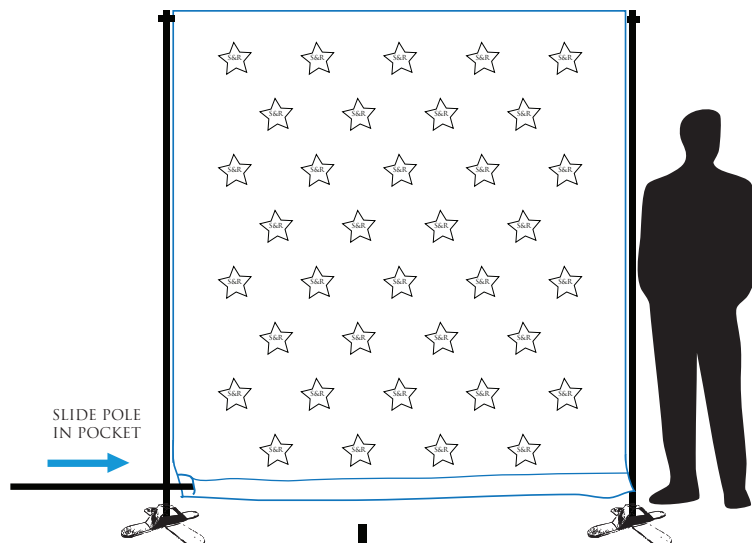

Attach the 2 Center Support Bars together. Hook the center bar onto the horizontal poles. It will go through the slit at the top and bottom of the banner.

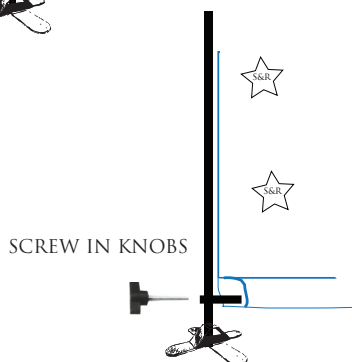

Use zip ties to stretch the banner taut against the stand. This avoids wrinkles and creases.

Voila! Your stand is complete!

Check Your Work!

- Make sure everything is secure and snug.
- Employ the use of sandbags on bases for added stability.
- If set up in a windy area, secure banner to outside support using ropes and/or place against a wall.

Storing your banner:

- Always roll the banner on a cardboard tube.
- Never fold the banner or it will get permanent wrinkles.

